

# REPAIRS, MODIFICATIONS, AND STRENGTHENING WITH POST-TENSIONING

LARRY KRAUSER

## ABSTRACT

Post-tensioning can be used for repairs, modification and strengthening of reinforced concrete and post-tensioned structures. The article describes some of the commonly used techniques and precautions for detensioning tendons, repairs and re-stressing of tendons. The article gives guidance to practicing engineers and contractors on techniques that can be used to create new openings in existing post-tensioned structures. The article also explores techniques for the strengthening of existing structures by external post-tensioning.

## KEYWORDS

anchorage; coupler; external post-tensioning; rehabilitation; repairs; strengthening; tendon.

## 1.0 INTRODUCTION

Due to the aging infrastructure, repair, modification and strengthening of existing structures is becoming increasingly important. This article provides guidelines and suggestions to assist owners and design professionals in repairs, modifications, and strengthening of structures using post-tensioning. Experienced specialty contractors and engineers have the know-how to develop and execute repairs of unbonded post-tensioning tendons, make modifications to existing unbonded post-tensioned structures, and strengthen structures utilizing post-tensioning.

Techniques for repairs of post-tensioning tendons are based upon time of discovery of the problem, type of tendons involved, and structure type. Discovering the necessity to repair a tendon prior to concrete placement is easier than afterward. Restoring integrity to button-headed wire tendons that were used in the industry in the early 1960s and 1970s can be intricate but achievable. Access to the structure and location of repairs also plays a pivotal role in the development of the repair strategy.

With changes in usage of existing structures, Modifications are becoming more common. Cutting openings into a post-tensioned floor system requires specialized knowledge, experienced personnel, and proper equipment. Thousands of structures have been successfully modified to accommodate tenant's needs after the completion of original construction.

Strengthening structures with post-tensioning tendons can be a cost-effective solution, because new, external high-strength steel tendons can be easily installed in the structure so that strengthening forces are applied where needed. The tendon geometry can easily be adjusted to work around the existing utility pipes and ducts and apply the forces at specific points of the structure. Applications of post-tensioning for strengthening of structures are diverse and only limited by imagination.

Post-tensioned systems have large active forces and only knowledgeable and experienced personnel should be involved in the execution of repairs, modifications, and strengthening.

---

PTI Journal, V. 4, No. 1, July 2006. Received and reviewed under Institute journal publication policies. Copyright ©2006, Post-Tensioning Institute. All rights reserved, including the making of copies unless permission is obtained from the Post-Tensioning Institute. Pertinent discussion will be published in the next issue of the PTI Journal if received within 3 months from the publication.

## 2.0 REPAIRS

Repairs to post-tensioning tendons are necessary when existing tendons are damaged, corroded, cut, broken, or have lost their force. This section focuses on the repair and replacement of damaged unbonded tendons. Prior to undertaking any repairs, a thorough investigation should be performed to determine the cause of the damage. Preventive measures should be implemented in the repair strategy to eliminate the cause. The investigation may include a structural analysis to determine the adequacy of the existing structure with the reduced forces possibly eliminating the need to perform repairs to damaged post-tensioning tendons.

Poor construction details and techniques are the primary causes of tendon deterioration. Lack of understanding of corrosive agents and their affect on steel has caused the deterioration of many types of structures (precast, steel, and cast-in-place concrete). Concrete porosity (which allows water and chloride infiltration), poor quality concrete, and concrete mixes containing chlorides have all been causes of tendon deterioration.

It is relatively easy and inexpensive to replace a tendon if the damage is discovered before the placement of concrete. Kinked or broken wires, fabrication errors, or excessive sheathing damage are some common types of problems that can occur during construction. Simple replacement of the entire tendon is the best method. Occasionally, damage to the tendon may be discovered prior to subsequent concrete placement in a continuous tendon; in this case, splicing the continuous tendon may be the best alternative; this is described in Section 2.1.1. Sheathing damage can usually be fixed prior to concrete placement without the need to replace the tendon; this is described in Section 2.1.2.

Once the tendons are encased in concrete, visual inspections to determine damage to the tendon are virtually impossible; however, some of the following tell tale signs may indicate areas of potential problems.<sup>1</sup>

- Strands erupting through the slab and strands popping out from anchorages
- Stains at grouted anchor pockets
- Leakage and cracks along tendon trajectories
- Cracks and spalls at end anchorages
- Grease on concrete surfaces
- Water leakage at expansion joints

There are a myriad of causes for tendon failures in concrete. Tendon failures can broadly be divided into failures that are caused during construction and failures that are caused after construction.

During construction care should be exercised not to drill or shoot pins into post-tensioned slabs where tendons may be located. Many times inexperienced contractors may drill or shoot column collars into concrete on top of the slab. This location is typically congested with tendons near

the top of the slab and shooting pins may cause damage to the tendons. Possible solutions are to increase tendon top cover, control the depth of drilling, or limit the length of shot pins. Also, mechanical contractors typically use hangers on the underside of slabs to attach utilities; these, are usually attached using pins shot into the slab that can damage the tendons at low points. Solutions include marking the locations of tendons on the bottom of slabs, increasing tendon bottom cover, controlling the depth of drilling, or limiting the length of shot pins.

In completed post-tensioned structures, tendon failures usually occur because of corrosion or due to tenant improvement contractors making openings into the slab without proper knowledge and understanding. Corrosion is typically the cause of most tendon failures in existing structures, primarily parking structures; however, corrosion has caused tendon failures in enclosed structures as well.

### 2.0.1 CAUSES OF CORROSION

The primary concern for corrosion is in post-tensioned parking structures. The building boom for parking structures closely followed the increased use of deicing salts. From the early 1950s until the early 1970s, the use of road salt on highways and streets increased ten fold in the United States. By the mid-1970s, it was recognized that corrosion of reinforcing steel was the primary cause of deterioration of highways. Bridge designers were ahead of parking structure designers in their awareness of this problem. Because of the lag in the transfer of knowledge from highway departments to private industry, parking designers did not begin to react to the corrosion problem due to deicing salts until the late 1970s and early 1980s.<sup>2</sup>

The post-tensioning industry recognized the effects of chlorides and corrosion on the deterioration of parking structures in the early 1980s, however, millions of square feet of post-tensioned parking structures had already been built by then. Fig. 1 shows the evolution of corrosion protection of unbonded strand tendons for buildings and parking structures. Paper wrapping was used into the 1970s for sheathing of unbonded strand and button-headed wire tendons until the industry recognized the corrosion potential of this technique and phased it out. Plastic sheathing was developed as an alternative to paper wrapping and is still in use today. However, the industry no longer uses a stuffed system where the strand is pushed through a pre-formed plastic duct or the heat-sealed method where the strand is coated and then a flat piece of plastic is bent around the strand and then seamed using heat. Extruded plastic sheathing is almost exclusively in use today – the P/T coating and plastic is extruded on the strand in a continuous process. The industry has further identified and advanced the corrosion protection of unbonded tendons with encapsulated and electrically isolated tendon protection techniques. The post-tensioning industry continues to develop and refine the techniques required to better protect their product from corrosion.

**Paper-wrapped  
1955 – 1975+**

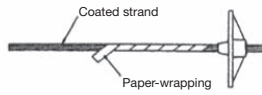

**Plastic Sheath  
1960 – Present**

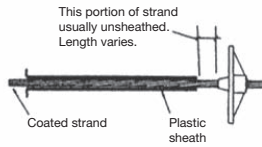

**1985 PTI  
Recommended  
System**

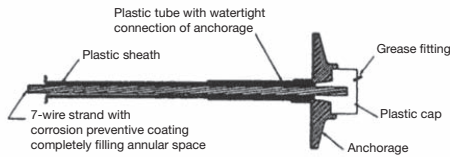

**Electrically  
Isolated Tendon**

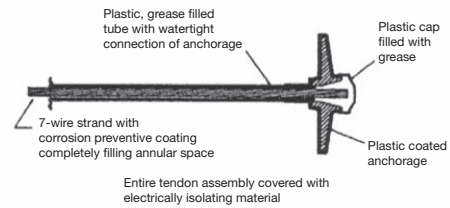
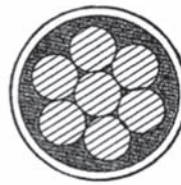

Fig. 1 – Evolution of Corrosion Protection for Unbonded Strand Tendons for Buildings<sup>3</sup>

Prestressed wires or strands often fail as a result of the loss of steel cross-sectional area due to conventional electrochemical corrosion (rusting) or brittle fracture due to hydrogen embrittlement or stress-corrosion cracking. These types of corrosion occur in the presence of water. Stress-corrosion cracking can occur without the presence of chlorides or other contaminants. The key is to prevent water from entering the tendon and attacking the prestressing steel. Some conditions that allow water to enter the system are:<sup>3,4</sup>

- Steel exposure during shipping, storage, and handling
- Improper protection of the tendons
- Damage to tendon sheathing
- Voids between the sheathing and the P/T coating (grease)
- Poor quality P/T coating (grease)
- Inadequately protected anchorages
- Improper grouting
- Cracks and concrete porosity (permeability)
- Insufficient concrete cover (placement tolerances)
- Joints or discontinuities of concrete members

It is important that the sheathing tightly encase the strands with high-quality P/T coating filling all the voids in the system thus preventing water intrusion. Fig. 2 illustrates three techniques that have been used to apply sheathing to



**Push-Through Preformed Tube**  
Strand pushed through as grease is applied.

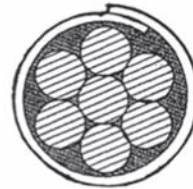

**Heat-Sealed**  
Formed from flat strip as grease is applied.

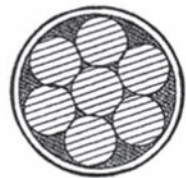

**Extruded**  
Formed by extruding over strand as grease is applied.

Fig. 2 – Plastic Sheathing Techniques for Unbonded Single Strand Tendons<sup>3</sup>

unbonded single strand tendons. Of the three types, the extruded technique has shown the best ability to eliminate voids. The push-through and heat-sealed methods have both shown susceptibility to water intrusion into voids and thus corrosion problems. The extruded system is used in almost all applications in North America.

**2.0.2 REPAIR OPTIONS**

The type of repair depends on:<sup>5</sup>

- The cause of the problem
- The need to maintain service of the structure during repairs
- Whether the repair is to a beam, slab, or other structural member
- Other factors, such as budget

The following sections discuss some of the options for repair and replacement of post-tensioning tendons. Repair of the concrete should follow the same practices as for non-prestressed structures. The repair or replacement of tendons in completed structures will typically fall into one of the following categories:

- Replacing damaged tendons
- Splice and re-tension at break
- Splice at break, re-tension at anchorage
- Total tendon replacement<sup>5</sup>

Fig. 3 shows the preferred location to cut and repair tendons. The preferred location should be where the tendon passes through the middle of the slab or beam and is not at a point of tendon curvature. This allows the greatest concrete cover to the repair (coupler) and typically coincides with the point of contra-flexure in the member. Most of the time this is approximately at the quarter point of the span in continuous members.

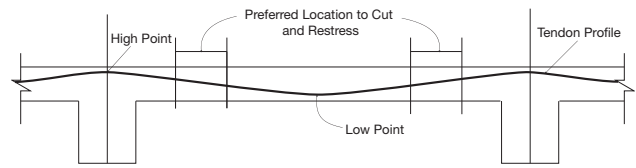

Fig. 3 – Preferred Location to Cut and Repair Tendons

## 2.1 UNBONDED SINGLE STRAND TENDONS

### 2.1.1 TENDON REPAIRS PRIOR TO CONCRETE PLACEMENT

When damage is discovered prior to concrete placement, complete replacement of the tendon is recommended. This re-instates the tendon to the original project requirements along with being the easiest and most cost-effective solution.

Installing a coupler onto the tendon and removing the damaged portion is the recommended when damage to a continuous tendon is discovered after a part of the tendon is already encased in concrete. The portion of the tendon beyond the damage that is not encased in concrete should be completely removed and a new tendon spliced to the existing portion of the tendon. Couplers should be installed at approximately quarter points along the length of the span. When damaged tendons are close to each other, it is recommended that couplers be alternated. Fig. 4 shows a plan view for replacing damaged tendons. Fig. 5 shows the procedure for coupling of tendons in a continuation slab pour.

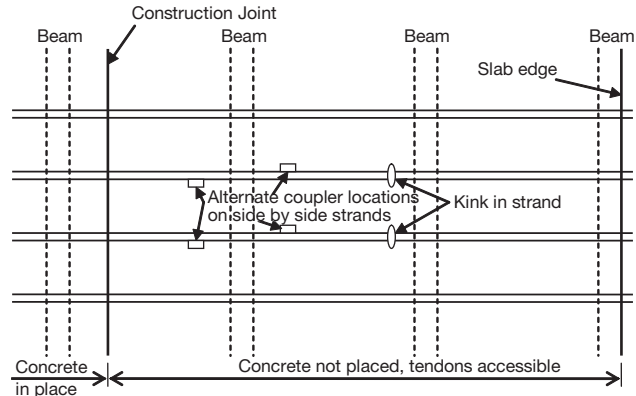

Fig. 4 – Replacing Damaged Tendons

The Engineer-of-Record should approve the locations and the techniques to be used for repairing and splicing tendons. Once the Engineer-of-Record approves the use of couplers, the following procedure for installing a tendon coupler onto unbonded single strand tendons is recommended by PTI.<sup>6</sup>

#### 2.1.1.1 PROCEDURE FOR INSTALLATION OF COUPLERS:

1. Coupler location should be determined by the post-tensioning supplier such that the coupler is in the middle of the member and not at a point of tendon curvature and approved by the Engineer-of-Record.
2. Couplers should not be located side-by-side. If more than one tendon requires splicing, couplers should be staggered at half bay increments.
3. A housing (PE pipe) of sufficient inside diameter to hold the coupler and of sufficient length to allow for subsequent movement shall be used. Also, an additional piece of sheathed strand of sufficient length to reach the edge from (with enough length for stressing) is required along with two pocket formers. P/T coating shall be used to fill the void in the housing.



Fig. 5 – Coupling Tendons in a Continuation Slab Pour

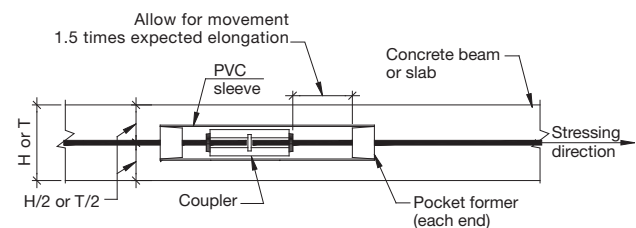

Fig. 6 – Coupler Installation Details

4. The tapered tip of the pocket former that normally fits inside the anchor cavity can be cut off when being used for splicing thereby reducing the length of the PE pipe needed.
5. The original strand is first cut with a saw or abrasive wheel at the coupler location and one pocket former is placed on the strand. Mark the strand before coupling to make certain that the proper length of strand has been fully inserted into the coupler. The original strand is then inserted into the coupling device.
6. The second pocket former is placed over the new strand, the strand marked, and the strand inserted into the coupler.
7. Using a standard jack, strand on each side of the coupler needs to be fully stressed for proper seating of the coupler wedges.
8. A pocket former is taped to one end of the PE pipe and the PE pipe is placed over the coupler. Then the PE pipe is tightly packed with P/T coating allowing no air voids. The second pocket former is affixed to the PE pipe completing a tightly sealed coupler.
9. The tendon coupler's location within the PE pipe must permit the coupler to move the required amount in the direction of stressing. Allowance for movement in both directions must be provided when the tendon is to be stressed from both ends.
10. A dark crayon or paint mark on the deck will facilitate locating the coupler after the pour should that become necessary if the above procedure was not properly performed.

### 2.1.2 SHEATHING REPAIRS IN AGGRESSIVE ENVIRONMENTS

The following procedure can be used for repairs to tendon sheathing in aggressive environment:<sup>6</sup>

1. Restore tendon's P/T coating in damaged area (if necessary).
2. Place split tubing over damaged area and extend 3 in. (75 mm) past each side. If split tubing is not available, un-damaged tendon sheathing can be substituted if two pieces are overlapped. Fig. 7 illustrates the two options.

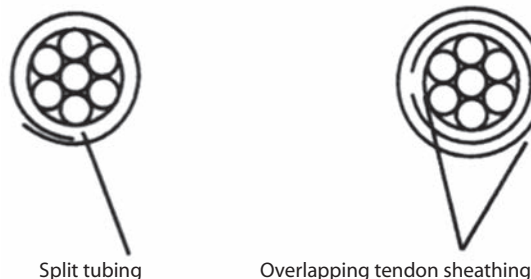

Fig. 7 – Procedure for Sheathing Repair

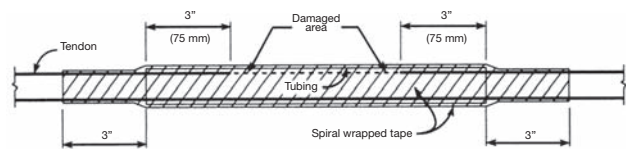

Fig. 8 – Restored Sheathing on a Damaged Tendon

3. Spirally wrap the entire length of the repair area with tape and extend past tubing by 3 in. (75 mm). Note that the tape material used shall be of suitable quality to allow for seal of tubing to be watertight. Fig. 8 illustrates this method.
4. Taping can be used in place of the above method if the tape material used can ensure a watertight tendon and no significant portion of the original extruded sheathing is missing (practical judgment should be applied to the term "significant"). Testing has demonstrated the successful repair of a  $\frac{1}{4} \times 2$  in. (6 × 50 mm) slot. Spirally wrap a minimum of two layers of repair tape extending a minimum of 3 in. (75 mm) past the damaged areas in both directions.

### 2.1.3 TENDON REPAIRS IN EXISTING CONCRETE STRUCTURES

Tendon repairs in existing concrete structures could involve strand, sheathing, and/or anchorages. Determining the proper procedures to repair the tendons depends on many factors, some of which are:

- Location of tendon damage
- Accessibility to anchorages
- Ability to remove tendons, sheathing, and anchorages
- Capability to use existing tendons, sheathing, and anchorages
- Undetected damage
- Additional protection required to the repaired structure

The following sections briefly describe some situations and possible procedures that can be used to repair tendons. Tendon repairs should be performed by qualified personnel only.

#### 2.1.3.1 SUPPORT/SHORE EXISTING STRUCTURE

Tendons that are cut or broken do not provide the design force to the structure. A competent Engineer should evaluate the adequacy of the structure and design a shoring system if necessary. The shores are typically placed along the entire length of the broken tendon. This could extend the entire length of the structure if the de-tensioned tendons are continuous from one end to the other. If a number of tendons are found to be de-tensioned on a floor, shoring may be required on the entire floor. In cases where all anchorages of a slab band have been damaged, releasing the force in the banded tendons, the shores should be placed along the entire length of the banded tendons.

### 2.1.3.2 LOCATE DAMAGE

In order to repair a tendon, determination of where it is cut or broken is necessary. In existing structures, visual inspection of tendons for damage is practically impossible. When strands erupt through the slabs or pop out of anchorages, it is clear that damage has occurred but it does not provide the location of the cut or break. In cases where coring holes or shooting pins has caused tendon damage, the location of the break or cut might be easier to determine. Sometimes, exposing the end anchorages can be useful in determining if a strand has failed.

In cases where the strand has popped out of the end anchorage, extracting the broken part of the strand and laying it on the top of the slab can provide a good indication of the approximate failure point. Similarly, when the strand has erupted through the concrete, pulling the strand out of the structure can provide an approximate location of the failure. When there are no obvious signs of strand failure, subtle indications such as rust stains at the grouted anchor pockets, leakage and cracks along tendon trajectories, cracks and spalls at end anchorages, grease on concrete surfaces, and water leakage at expansion joints could provide starting points to determine the location of the cut or break.

### 2.1.3.3 LOCATE TENDONS

Tendons must first be located before they are repaired. Ground Penetrating Radar (GPR) is commonly used to locate tendons. Pachometers or X-rays can also be utilized to determine the locations of tendons and anchorages. Occasionally, careful concrete removal may be necessary to find the tendons and anchors.

### 2.1.3.4 DETENSIONING OF TENDONS

In most cases tendons need to be detensioned before repairs can be made. In most cases requiring repairs tendons are already broken or cut and do not require additional work. However, in some cases the tendons may still have some residual force, these tendons need to be detensioned before repairs can be made. There are several methods to detension tendons in existing structures; all of which are dangerous and should only be performed by knowledgeable experienced personnel. Tendons could erupt during detensioning. To avoid injury the area along the length of the tendon being detensioned should be kept clear of people. Also, concrete at the end anchorages should be protected from “blowing out” during detensioning.

- **Through anchorages:** Tendons can be detensioned through existing end anchors by slowly exposing the wedges and strand to low heat.
- **Drilling into strand:** Tendons can be detensioned by slowly drilling into the strand. This is only possible if the exact location of the strand is known. It should take place where the strand passes through the center of the slab thickness and near the center of the tendon length.

- **Burning through strand:** Tendons can be detensioned by slowly exposing the strand to low heat. The strand will need to be exposed by chipping the concrete or drilling a hole next to the tendon. Care must be taken when exposing concrete to heat because the concrete can explode.

**Jackhammering behind the anchorages is prohibited for detensioning tendons since this can result in sudden release of energy and cause serious injury to the personnel.**

### 2.1.3.5 EXPOSE TENDONS

Tendons should only be exposed after they have been detensioned. Only a small portion of tendon may need to be exposed to replace or splice it. The Engineer should determine where the tendons are to be exposed – this will depend upon the factors that created the need for the tendon repair or replacement. The concrete is typically chipped with jackhammers to expose the tendon. Care must be taken not to damage the strand or the sheathing especially if it is to be reused.

The extent of the strand that may be exposed in some typical situations is:

- **Anchor Replacement:** The concrete should be excavated around the existing anchor. Any tendons within the vicinity of the anchor to be replaced must also be detensioned otherwise a “blow out” could occur. Sufficient amount of concrete should be removed to install the new anchor and any additional back-up steel that may be required. This procedure can only be used if the tendon or part of the tendon will be replaced otherwise the strand may be too short to pass through the replacement anchor.
- **Replace and Recess Anchorage:** When a tendon has failed due to a faulty or corroded anchorage and the existing strand is re-used, the new anchor must be recessed into the structure. The required amount of recess will depend on the length of the unstressed strand. The anchor may need to be recessed at least several inches more than the lost elongation to allow a stressing jack to be attached to the tendon.
- **Splice:** An experienced contractor and/or engineer should determine the location of the splice. The size of the excavation will depend on the number of strands to be coupled at the splice location and the thickness of the concrete. When there is only one tendon in the group, the width of the excavation is approximately 4 in. (100 mm) and the length should be at least 12 in. (300 mm) longer than the coupling device.

When there are two tendons in a group the couplers should be staggered, the width of concrete excavation should be about 6 in. (150 mm) to allow the second tendon to pass the coupling device. Both tendons need to remain in the same horizontal plane to

keep the profile consistent. When there are more than two tendons in a group, special considerations are required to determine the extent of concrete removal.

- **Inserting replacement strand:** Typically, replacement strand will be inserted from one end of the structure, in which case only the throat of the anchor will need to be exposed. However, there are circumstances that require insertion in the middle of the structure. Many times a coupling device will also be used in this location so the amount of excavated concrete would be similar to the above. Occasionally, replacement strand will be inserted in both directions from somewhere in the middle of the structure. In this case, the depth of concrete excavation is only to the depth of the tendon and the size of the excavation will depend upon the techniques that will be employed to insert the new strand.

#### 2.1.3.6 SPLICE TENDONS

- **Strand coupler:** Single strand couplers are used to splice tendons. When installing couplers into existing concrete members, the procedure to install the coupler is the same as installing it prior to concrete placement. This procedure is described above in 2.1.1. Fig. 9 shows couplers in place in a slab repair application.
- **Intermediate stressing anchorage (Dog bone):** Intermediate stressing anchorages are used when existing strand will be stressed from an interior location and the end anchorages (that are holding) cannot be accessed. Dog bones are placed at approximate quarter points similar to couplers. The size of the excavation will depend on the manufacturer of the intermediate stressing anchorage and the type of stressing equipment used. Since the use of an inter-

mediate stressing coupler requires a strand stressing tail, the intermediate stressing anchorage is normally used in conjunction with a strand coupler. The length of the existing detensioned tendon is normally not sufficient to connect to the dog bone because the elongation has been removed from the tendon length; therefore, a new piece of strand is spliced to the existing tendon with a coupler to connect the existing tendon to one end of the dog bone. See Fig. 10.

#### 2.1.3.7 REPLACE TENDONS

Tendons need to be replaced when they are damaged. There are several methods that can be used to remove and replace tendons in existing structures. The following section describes some techniques that can only be used if the strand has been detensioned. The manufacturing process used to apply the sheathing (Fig. 2) to the in-place tendon can make a difference as to the ease of removal and replacement. Sheathing applied by the push-through method has the most room, closely followed by the heat-sealed method. The extruded method makes a tight system eliminating most air voids, but because of the tightness leaves the least amount of space when replacing tendons.

The following paragraphs describe techniques that are used to remove strand depending on the situation:

- **Using stressing jacks:** In this method a stressing jack is attached to the end of the strand at the anchor. The jack is then cycled until the strand is completely removed. If the strand does not protrude far enough beyond the anchor to reach the jack grippers then a jack chair and coupler with a short piece of strand can be used to extend and grip the strand. Typically, one or two cycles will extend the strand far enough so that the jack can bear upon the existing anchor and attach to the strand being removed.



Fig. 9 – Couplers for Slab Repair

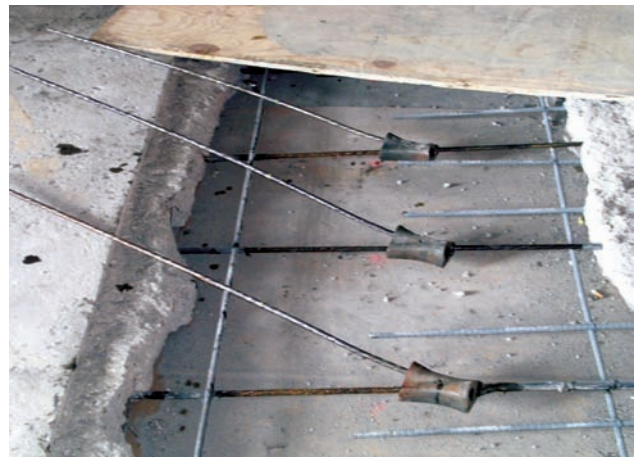

Fig. 10 – Intermediate Stressing Anchors for Slab Repair

- **By hand:** Another method that has been successful and efficient is to pull the strand out by hand. The success of this method will depend on the length of the strand (the shorter, the easier), the type of sheathing jacket (the looser, the easier), the quality of the remaining P/T coating (the better lubricated, the easier), and the drape (lots of drape causes more friction). To begin this method a minimum amount of strand must be available to grab on to. Pulling the strand out by hand can be done from the ends or in the middle if the strand has erupted through the concrete. An anchor with wedges can be installed on the strand to make a grip to pull against.
- **Using other types of equipment:** Pulling the strand out of the concrete can also be accomplished by using forklifts, electric wenchers, cranes, and even trucks and automobiles. Using equipment in this way can be dangerous and should only be attempted by experienced personnel. A smooth steady force should be slowly applied to the strand.

The following paragraphs describe techniques that are used to insert new strand into the empty sheathing. P/T coating is liberally applied to the replacement strand as it is being inserted to reduce air voids. Many times a coated (greased and wrapped) strand is used and the sheathing cut off as it is being inserted into the duct. When coated strand is used, additional P/T coating is also applied as the strand is inserted.

- **Smaller size strand:** Sometimes it may be possible to substitute a slightly smaller size strand. The Engineer must be consulted to determine if substitution is permissible. The smaller size strand can usually be pushed in by hand. The end of the strand should be rounded so that it does not catch on the plastic sheathing that it is being pushed in to.



Fig. 11 – Stressing of Tendon at Intermediate Stressing Anchor

- **Pulling strand in with a rabbit:** In this method a smaller size strand or wire is first pushed through the existing sheathing. Then the small strand or wire (rabbit) is brazed onto the replacement strand. The rabbit is then pulled out leaving the replacement strand in the concrete. The end of the replacement strand is cut off past where the rabbit was brazed to it. This removes part of the strand that may have been metallurgically modified by current passing through during the brazing process.
- **Pushing in using stressing jacks:** The replacement strand can also be inserted by pushing with a stressing jack. When this method is used, the jack must be modified to be attached to the structure. The jack is then cycled to push the strand into the structure.

Sometimes experienced ironworkers can merge removal and replacement into one task. Typically this will involve brazing the replacement strand onto an end of the strand being removed.

### 2.1.3.8 RE-TENSION TENDONS

Prior to re-tensioning the tendons, they must be completely restored as required by the contract documents. This might mean re-applying P/T coating, sheathing, corrosion protection, and affixing these together to form a watertight system.

Once the tendons have been replaced, coupled, or new anchors installed, they are tensioned to full force. Similar techniques are used for stressing and recordkeeping as in new construction. When new end-anchors are used, they must be concreted in prior to tensioning. When the tendon is stressed at an intermediate anchorage, the concrete excavation is filled in after tensioning and approval of stressing records by the Engineer. Fig. 11 shows stressing of dog bones prior to replacing concrete.

### 2.1.3.9 FINISH REPAIRS

Upon completion of re-tensioning, the remainder of the concrete repairs can take place. The concrete repairs will follow the similar practices to those used for concrete repairs of non-reinforced concrete structures.

## 2.2 UNBONDED BUTTON-HEADED WIRE TENDONS

Unbonded button-headed wire tendons were used for a short period of time in the United States in the 1960s and early 1970s. The system typically consists of ¼ in. (6 mm) diameter, 240 ksi (1650 MPa) stress-relieved wires with a cold-forged “button-head” of about ⅜ in. (9 mm) diameter at each end. Unbonded tendons used in building construction contained four to ten wires. The shop-fabricated wires were greased (or waxed), sometimes by hand, and protected by a spirally wrapped, reinforced kraft paper producing a tight bundle of wires. The button-headed wires passed



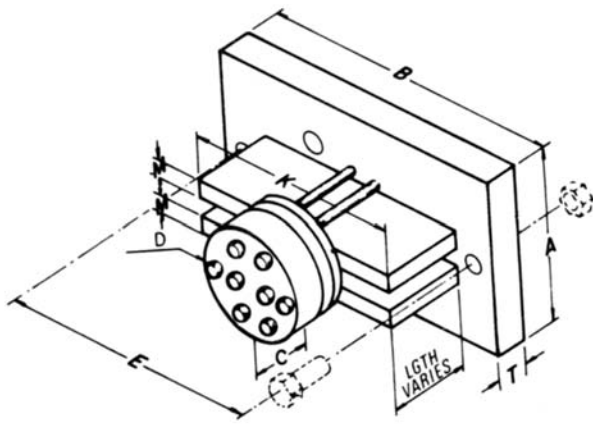

Fig. 12 – Sample Stressing-End Anchorage Assembly for Unbonded Button-Headed Wire Tendons<sup>7</sup>

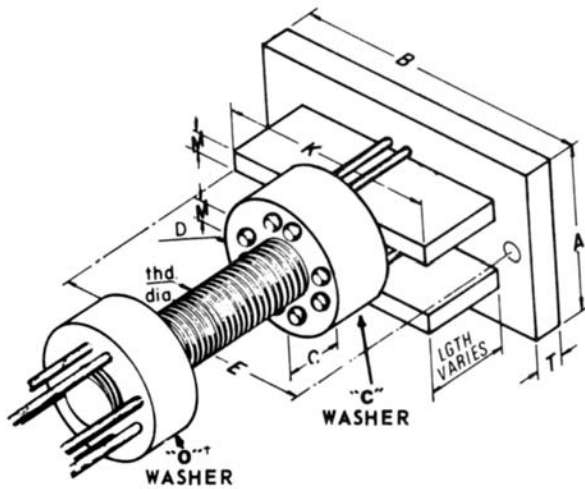

Fig. 13 – Sample Intermediate Anchorage Assembly for Unbonded Button-Headed Wire Tendons<sup>7</sup>

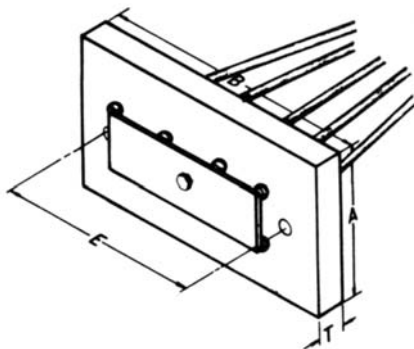

Fig. 14 – Sample Fixed-End Anchorage Assembly for Unbonded Button-Headed Wire Tendons<sup>7</sup>

through an anchor plate; the anchor plate was pulled and shims inserted to maintain tension in the wire tendons. Fig. 12 illustrates a stressing-end anchorage, Fig. 13 illustrates an intermediate anchorage, and Fig. 14 illustrates a fixed-end anchorage.

Many unbonded button-headed wire tendons were used in parking structures prior to the realization of the effect road salt and de-icing chemicals could have on steel corrosion. In the early days the construction industry's perception was that the concrete provided corrosion protection for the post-tensioning system. The purpose of the sheathing (reinforced kraft paper) was to provide a bond breaker so that the wires could move freely (remain unbonded) after the concrete was placed. The function of the grease (or wax) was primarily as a lubricant to reduce friction during stressing.

Since then the perception of the industry has changed significantly. There have been many articles written about the effect corrosion has had on these post-tensioning systems. Failures of this system in parking structures can be traced to the fact that little was known about corrosion when the structures were constructed. It is easy to look back and see the inadequacies of the system in relation to corrosion, primarily: exposed wire and steel at anchorages, paper wrapping as sheathing, and inadequate grease (or wax) whose purpose was as a lubricant not corrosion protection.

The following discusses repair techniques/situations that are applicable to repairing/replacing unbonded button-headed wire post-tensioning tendons. Many of the techniques described in 2.1.3 above for tendon repairs in existing concrete using unbonded single strand tendons are applicable to button-headed wire tendons as well. Common sense should be used when applying them. The specialty contractor and engineer in charge of the repair should ascertain whether any patents exist for repair techniques they might chose to use.

- **Construction Joints:** Where construction joints were used in parking structures, the button-headed wire system was extremely vulnerable. Bare wires existed for a minimum of 18 in. (450 mm) in each direction exposing them to corrosion at intermediate anchorages. Corrosion at intermediate anchorages has caused the failure of the tendons in many cases.

In situations where the intermediate anchorages are damaged at construction joints but the remainder of the wires between anchorages are in good condition, repairs can be made by adding a replacement pour strip. The size of the pour strip would depend on the distance to the good wire from the construction joint. A new flared transition area from the new bearing plate to the paper wrapped tendon may be required. The pour strip should be sufficiently large for the length of the shims and access for stressing equipment.

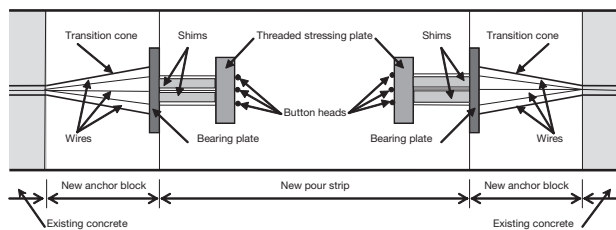

Fig. 15 – Details of Replacement Pour Strip

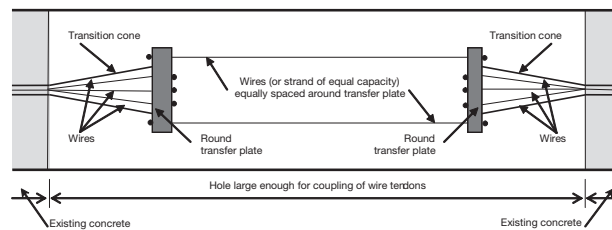

Fig. 16 – Details of Coupling Button-Headed Wire Tendons

Fig. 15 shows a cut through a replacement pour strip. Concrete in the new anchor blocks should be placed prior to stressing of the tendons. New transition cones, bearing plates, shims, and anchors should be supplied and installed by the contractor. A button-heading apparatus is used to field form the button heads on the tendon ends.

- **Replacing Anchorages:** When it has been determined that the wires are good but the anchorages need replacement, a technique similar to that shown above in Fig. 15 can be used. Sufficient amount of concrete should be removed to provide space for the new anchor block. For an end anchorage, this method recesses the bearing plate away from the edge of the slab. The Engineer in charge of the repair should analyze the structure to confirm its adequacy with the recessed bearing.

Fixed-end anchorages can also be replaced. The primary difference from that described above is that shims would not need to be necessary and concrete is placed over the entire anchorage prior to stressing at the other end.

- **Coupling Wire Tendons:** Coupling of wire tendons can be accomplished by removing sufficient concrete to allow new transition cones on each side. A fixed end is applied to each end of the tendon at the break. An even number of wires of equal capacity is attached through the fixed-end bearing plates with button-heads. As an alternative to button-headed wires, prestressing strand could also be used, see Fig. 16. Once the integrity of the tendon is re-established, the tendons can be stressed from the end anchorages. This repair procedure can be dangerous and should only be attempted by experienced personnel.
- **Removing Corroded Wires:** This is not as easy as it might sound and each tendon could be different. The wires are bundled and interlaced. It is typically advisable to remove all of the wires in a tendon simultaneously. Varying degrees of corrosion on the wires will effect removal. Kraft paper sometimes becomes entangled in or affixed to the wires, which

makes it difficult to remove the tendon. Sometimes holes will need to be provided every 10 ft (3 m) or so to access the wires. In this case the wires are typically removed in 10 ft (3 m) sections.

- **Replacing Wires with Prestressing Strand:** Many times prestressing strand will be used as a substitute for the force provided by the wire tendons. The Engineer in charge of the repair determines the quantity of strand necessary to achieve the desired replacement force. Wires do not normally replace wires because of the advancements in technology with prestressing strand.

Pushing or pulling strands into paper-wrapped tendons is very difficult. The paper tends to ball up in front of the strand obstructing it and making it difficult to push. Refer to the discussion in Section 2.1.3 for techniques on inserting strand. Brazing the strand onto a wire prior to its removal, may not work because of the paper balling up.

Even when holes are provided every 10 ft (3 m) or so, insertion of strand is difficult. Sometimes the easiest procedure is to cut troughs in the concrete to expose and remove the wire and paper. The strands can then be laid in the troughs. The trough should be made to match the desired drape of the tendon. The trough can be made either on the soffit or the top of the slab. The troughs on top usually extend over the supports to the quarter point and on the soffit through the middle of the slab to the quarter point.

### 3.0 MODIFICATIONS

Experienced Engineers and Contractors should perform the modifications to existing post-tensioned concrete structures. Many times structures may require modifications due to changes in building use or changes to the building codes. These modifications could involve cutting openings, such as those for stairs, elevators, and escalators. While this does not create extraordinary problems for post-tensioned structures, special methods are necessary for successful modification of post-tensioned structures.

Cutting holes and openings in post-tensioned slabs requires specialized equipment and knowledgeable field personnel in order to avoid accidentally releasing any post-tensioning strands. The process typically involves accurately locating tendons, excavating concrete around tendons, detensioning and cutting the tendons, and re-anchoring them at the edge of the new opening. If tendons are only in bands or beams, openings can easily be located in the slab panels where there are no tendons with little, if any, additional strengthening. Where tendons pass through openings, some strengthening may be necessary and should be installed prior to cutting into the slab.

The tasks described below provide guidance when cutting an opening into a slab containing unbonded tendons. There are many variables involved with this type of modification that cannot be fully described or anticipated; therefore, a thorough evaluation of each situation must be undertaken by an experienced Engineer.

- **Confirm opening design:** The Engineer must review as-built drawings and confirm that the opening can be located where necessary. The Engineer should analyze the structure and design any additional strengthening that may be required. The Engineer and Contractor should review the construction sequence to confirm the adequacy of the structure at each step of the modification.

During the review of the construction sequence, a determination should be made on how the tendons are to be anchored at the new opening. The following two techniques are commonly used:

1. The tendon is detensioned and a new anchor is cast at the edge of the new opening.
2. A split anchor is installed on to the strand to hold the force prior to detensioning. Fig. 17 shows a trouble-shooting anchor that is typically used for this purpose.

Strengthening, if required, should be installed prior to any concrete removal or tendon detensioning. Fig. 18 shows a situation where new perimeter beam was added at the new slab edge prior to detensioning of tendons.

- **Support/shore existing structure:** The structure should be supported at the locations required by the Engineer. As a minimum, shores should be located along the length of the tendons to be detensioned.
- **Layout the opening:** The outline of the opening is marked on the top of the slab. Then the amount of concrete to be removed beyond the edge of the new opening for affixing anchorages is marked.
- **Locate tendons:** Tendons need to be located before the openings are cut in the slab to avoid damage. The approximate location of the tendons should be noted on the top of the slab so that workers have an idea



Fig. 17 – Trouble-Shooting Anchor



Fig. 18 – New Perimeter Beam at the Edge of Opening

where they are located. Tendons can typically be located by GPR, pachometer, or by x-ray. The approximate location of non-prestressed reinforcing steel can also be located in this manner.

- **Split anchors:** When using split anchors, an opening is carefully made around the tendons at the new anchorage location. A bearing plate with a slot is inserted over the strand and grouted for full bearing. The sheathing is then removed and a split anchor is installed on the strand; wedges are inserted into the split anchor and seated. Once split anchors are installed on both sides of the opening, the tendons can then be detensioned between the anchors. Fig. 19 shows installation of split anchors.



Fig. 19 – Installation of Split Anchors

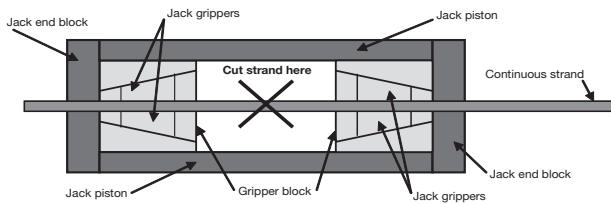

Fig. 20 – Illustration of a Specially Configured Jack for Detensioning



Fig. 21 – Detensioning Tendons by Heating with a Torch

- **Remove concrete:** Concrete should be removed carefully around live tendons for the new opening. If the structure is supported and tendons are detensioned prior to concrete removal, not as much care is needed.
- **Detension tendons:** Tendons can be detensioned in a variety of ways. Several methods that can be applied when cutting openings are described in 2.1.3.

If there is no concern that the tendons will burst out of the end anchorages, the tendons could be detensioned by severing the strands by saw cutting in the center of the new opening. The structure would have to be supported along the lines of the tendons since the tendons would no longer provide support.

Once the concrete has been excavated and the tendons exposed, the strands can be detensioned. One method that is sometimes used is to attach a specially configured jack to hold the tendon at two points. The strand is then cut in the middle and the jack released so the tendon slowly loses force. When using heat to detension the strand, the equipment and any nearby strands need to be heat protected. This scheme results in shock-free, controlled detensioning and prevents sudden release of energy that might push the wedges out of the end anchorages.<sup>3</sup> Fig. 20 illustrates how the jack can be configured.

Another method, once the tendons have been exposed, is to heat the strand to release the force. This process will result in the strands suddenly releasing all their energy and possibly pushing out of the end anchorages. In addition, the sudden release of energy could result in vibrations passing through the structure. There is usually a loud bang associated with this detensioning method. This detensioning technique is used often for new openings. Fig. 21 shows detensioning of tendons by heating with a torch.

As described earlier it may sometimes be desirable to install the split anchors on each side of the opening before cutting the strand. Thus only detensioning the strand within the opening; the force is maintained in the tendons outside the opening.

**Note:** Detensioning of tendons is a dangerous process and should only be performed by experienced personnel.

- **Set new anchors:** After completion of detensioning and concrete removal, new anchors can be set at the edge of the new opening. When a group of tendons are detensioned, concrete must be removed far enough to allow flaring of strands into the new anchors. Slab and edge forms should be set in place and new anchors along with any non-prestressed reinforcing steel should be installed. The strands are inserted into the new anchors, just as in new construction, and then the concrete is placed.
- **Re-tension tendons:** Once the new concrete has reached the desired strength for stressing, the strands can be re-tensioned. Tendons are normally stressed from the ends in the new opening. However, if the strand has been pushed out at the exterior anchorages during detensioning, the strand and wedges at the exterior anchorage must be re-set and stressing could take place either at the exterior or the new

opening. When re-tensioning tendons, the same procedures are used and records kept that are common to new construction.

- **Finish opening:** The tendons are finished and stressing pockets patched after approval of stressing records. Forming and supports are removed after the tendons are stressed.

#### 4.0 STRENGTHENING

Structures need to be strengthened for a variety of reasons: change of loading, modification of usage, incorrect construction practices, damage to the structure, or even a design error. Post-tensioning tendons offer a structurally sound and economical option for strengthening existing structures. External tendons can easily be attached to structures or the added tendons can be encased in concrete.

#### 4.1 DESIGN CONSIDERATIONS

Only experienced Engineers should perform the design necessary to strengthen existing structures with post-tensioning tendons. The specialized design is a balancing act that adds strength at the required locations while not creating additional distress in the remainder of the structure. The following addresses some of the items that need to be considered. However, structures and individual situations can be so diverse that not all circumstances can be identified and reviewed. Many variables and intuitive thought processes go into successfully strengthening structures with post-tensioning.

##### 4.1.1 PROFILES

Tendon profiles are typically made up of parabolic segments and straight lines. In new construction, a reverse parabola or partial parabola is generally utilized. For strengthening with external tendons, straight-line profiles are more appropriate.

Two extremely important concepts of external post-tensioning are illustrated in Fig. 22:

1. Changing the tendon force will alter the vertical force exerted on the structure, and
2. Changing the tendon eccentricity will alter the vertical force exerted on the structure.

By utilizing these two factors, the Engineer can fine-tune the force applied to the structure. Large amount of post-tensioning force in the horizontal direction would require a small amount of vertical offset while increasing the depth of the tendons would require a smaller tension force in the tendons to achieve the same vertical force. Experienced Engineers are able to use these concepts to optimize the design based on the design requirements and site constraints.

When strengthening tendons are encased in concrete that is made integral with the existing concrete, the design concepts

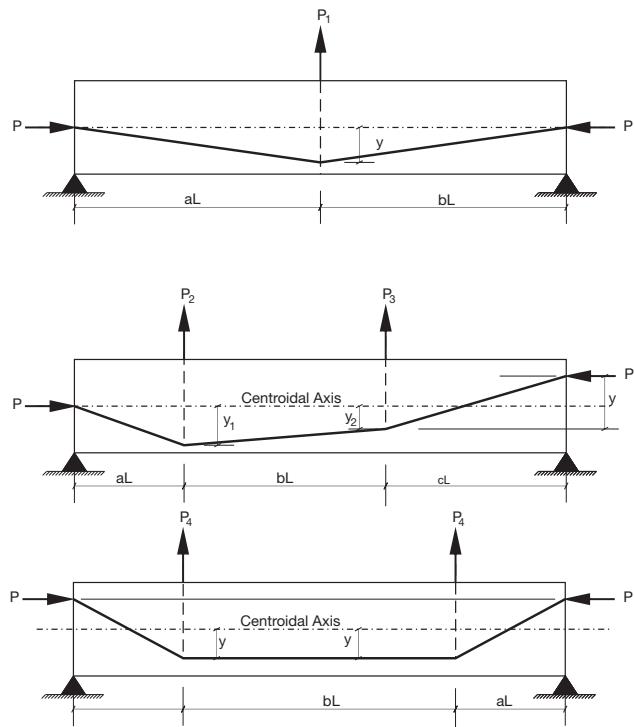

Fig. 22 – Straight Line Tendons<sup>9</sup>

used to engineer the strengthening are an extension of the original design. A critical point is to have the existing concrete and the new concrete act together as if they are one. Parabolic or straight line tendons can be used when encased in concrete. Many times strengthening tendons are stressed prior to concrete placement to confirm the uplift force and/or not to place undo stresses on thin encasement concrete.

##### 4.1.2 SUPPORTS

Supporting tendons used to strengthen structures is an important aspect of the strengthening design. It involves the mechanics of transferring the force into the structure. From Fig. 22, sharp angular changes in the tendon profile can exert significant concentrated forces on the structure. Supports transfer this force to the body of the structure. The quantity of support points depends on the process the Engineer used in designing the transfer of the force to the structure. The following are several methods that the Engineer may choose:

- **Single Point.** Usually used to strengthen structures at point loads.
- **Multiple Points.** Used to strengthen structures at multiple point loads or to strengthen elements that can span between support points.
- **Uniform Points.** Used when the strengthening load needs to be uniformly applied. Also used when strengthening tendons are encased in concrete and stressed after the new concrete is placed.

Attachment of supports to structures can be either fixed or free. If the support is rigidly attached to the structure, normally the tendon will be free to move over the support; conversely, when the support is free, the tendon will be affixed to it. Occasionally, the support and tendon will both be free to move.

Another aspect of the design of supports is that their bases must be designed for punching shear. Meaning the base must be large enough not to punch through the structure. This is more important when strengthening slabs and wood structures than with beams and steel structures.

The supports must also be designed so that they will not fail when loaded. The eccentricity of the tendon plays a role in this aspect of design because the longer and skinnier the support is the more probability that it could buckle under load. Differing shapes of supports will be discussed later.

#### 4.1.3 ANCHORAGES

The design of anchorages is critical in external post-tensioning applications. The location of the anchorages must be carefully considered to not affect the structure adversely. The anchorage points apply additional horizontal force and vertical forces to the existing structure. It is important that the structure be checked to ensure that it can support these additional forces.

Anchorages are attached to a soffit (slab or beam); passed through a beam or column and anchored on the vertical surface; or attached to a bracket that envelops a column. Some factors that need to be considered in the design of anchorages are:

- **Attached to soffit:** When the forces are relatively small, the tendons can be attached to the slab soffit with drilled anchors. Fig. 23 shows an example of a single strand anchorage at the soffit of a slab. The attachment devices must be able to handle the shear force that is the horizontal component of the tendon's force. They must also be able to clamp the anchorage to the soffit overcoming the vertical component of the tendon force so that the anchorages do not dislodge.
- **Through a beam or column:** External tendons can be easily attached to existing beams. The bearing plate of the anchorage must be designed to safely distribute the forces from the anchor to the concrete. The designer should also check the existing reinforcement in the beam to ensure that it can safely transfer the forces to the existing structure.. Also, when passing through a beam, the existing beam must be able to handle the sideways bending induced by the tendon force. Fig. 24 and Fig. 25 show the critical locations of induced forces when strengthening tendons pass through a beam.
- **Bracket at column:** It may sometimes be possible to drill through the column or attach a bracket to support

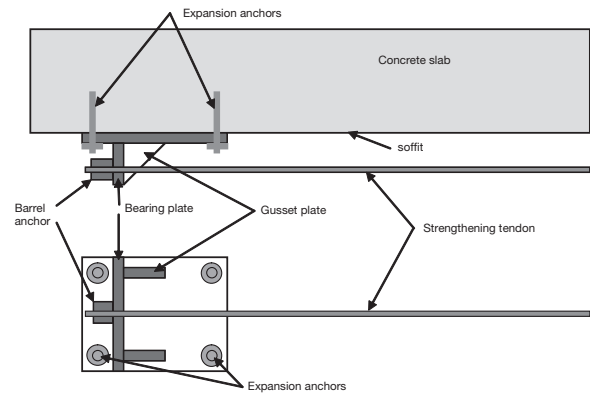

Fig. 23 – Anchorage Device for Single Strand Strengthening Tendon

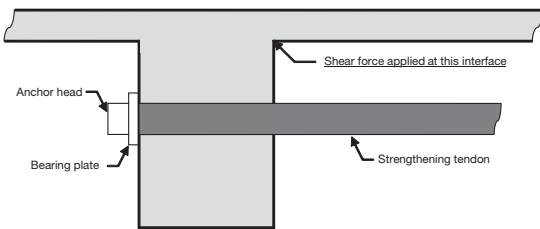

Fig. 24 – Cut Through Beam Indicating Critical Location of Shear Force

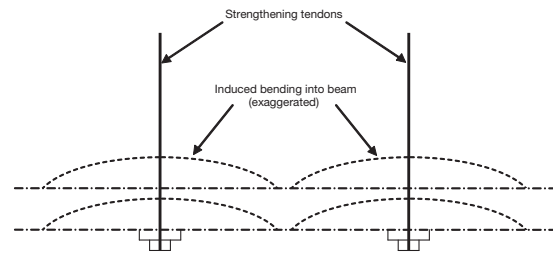

Fig. 25 – Plan View Indicating Induced Bending in the Beam

the anchorage at the columns. The bracket must be designed to have sufficient bearing to distribute the loads from the tendon to the concrete. The column must be checked for shear capacity at the anchorage location. Shear reinforcing may be used to reinforce the column. Fig. 26 shows an example of a column bracket.

External strengthening applies axial forces on the structure, the Engineer should evaluate the axial capacity of the structure to confirm that axial forces can safely be transferred from the tendon to the structure.

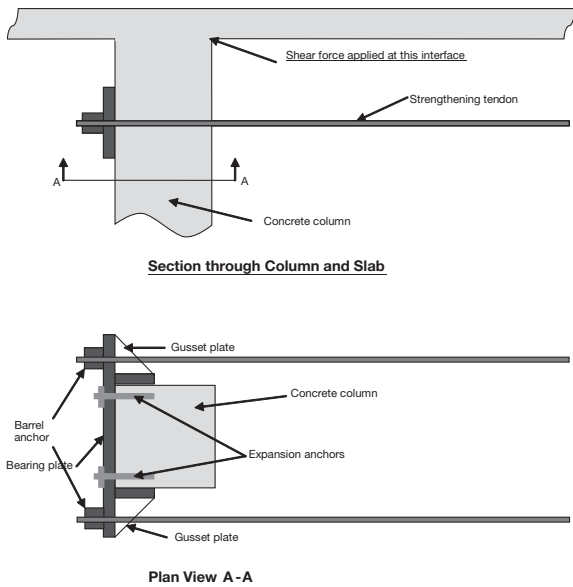

Fig. 26 – Anchorage Bracket at Column

#### 4.1.4 PROTECTION

Internal strengthening tendons encased in concrete are protected in similar fashion as new construction. Concrete cover for fire and corrosion protection is established by Code.

Because of the nature of structure strengthening, encasing tendons integral with concrete is not always possible; The Engineer has to use intuitive judgment in determining the project's protection requirements. External strengthening tendons can be encased in concrete or grout filled pipes or encased by precast channels for fire protection when required. Corrosion protection of the tendons can be provided by encasement, greased and sheathed strand, galvanized strand, or epoxy-coated strands. Brackets, pipes, posts, and anchorages can be similarly protected.

#### 4.2 BEAMS

Concrete, precast, wood, and steel beams can also be strengthened with external or encased post-tensioning tendons. Each structure or strengthening scenario is different, the Engineer must use judgment when applying the information contained herein.

Prior to determining the tendon force, the Engineer should establish the tendon profile (straight line or parabolic) and the required uplift loading. The Engineer should also decide whether the tendons will be external or encased. Similarly, any fire or corrosion protection requirements should be recognized. Any height limitations affecting the tendon eccentricity should be identified. The Engineer in most cases should work with an experienced contractor when formulating the construction procedures for the strengthening.



Fig. 27 – Deviated Beam Strengthening Tendons

Fig. 27 shows the strengthening of a beam with external tendons. An equal number of tendons are typically used on each side of the beam. Tendon force and eccentricity are adjusted until an optimum solution for the required uplift force is obtained. Generally, tendon eccentricity is established by the structure's geometry, however small adjustments can be made by adjusting the vertical location of the tendon anchorage. Profiled or harped tendons are typically strands while straight tendons can either be bars or strands.

Strengthening tendons encased in concrete will generally have a parabolic profile. The profile can be easily accomplished with dowels inserted into the existing beam. When new concrete and existing concrete are to act integrally, the Engineer must design the details of attaching the new concrete to the existing for proper transfer of forces. Minimum amounts of non-prestressed reinforcement in new concrete, dowels to existing concrete, bonding agent, and roughness of the existing concrete are some items to be considered in the design of the interface between the new and existing concrete.

When using external tendons, the support points and anchorages must be analyzed (4.1.2 and 4.1.3 discuss supports and anchorages respectively). For beams, support points can be made with steel pipes or brackets. Steel pipes can be placed against the beam soffit extending out on either side to support the tendon or the existing beam may be cored to insert the pipe. Pipes need to be designed to transfer the load to the structure. Brackets at the soffit of the beams offer more flexibility than pipes. Tendon geometry is easily adjusted with brackets and they can be placed at multiple locations along the beam. Fig. 28 shows an example of a beam bracket and Fig. 29 shows how multiple beam brackets can be used to establish tendon geometry.

#### 4.3 FLOORS

Floors are typically strengthened with external post-tensioning tendons. Each structure or strengthening scenario can be different and not all circumstances can be identified

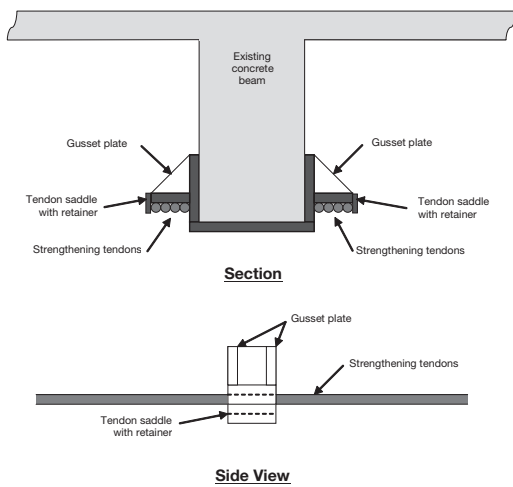

Fig. 28 – Sample Beam Bracket

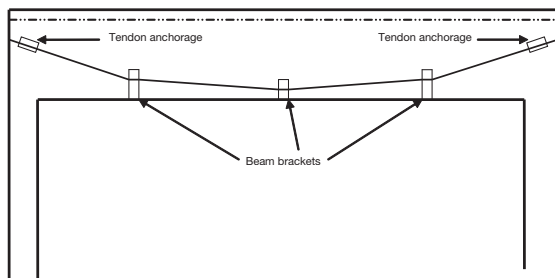

Fig. 29 – Tendon Geometry Using Beam Brackets

and described in this article. The Engineer must use judgment when applying the information contained herein.

Straight-line profiles for floor strengthening tendons are generally used with single support points at the center of the slab span. Structures with beams supporting one-way slabs are the easiest for slab strengthening because holes can be drilled through the beams at high points. Without a beam, some kind of a bracket would need to be devised that would hold the tendon close to the slab soffit. Support points at mid-span of the slab are normally constructed out of a steel tube with a base sized to transfer the uplift force into the slab. The tendon typically rests in a saddle with side retainers. The tendon eccentricity is adjusted with the length of the support post. Fig. 30 shows a sample of a slab support post.

Single strands are normally used for slab strengthening. Tendon spacing is determined by the required amount of uplift and the height of the support post. Tendon anchorages can either be placed against a beam or attached to the slab soffit along the perimeter (4.1.3 provides more information on anchorages).

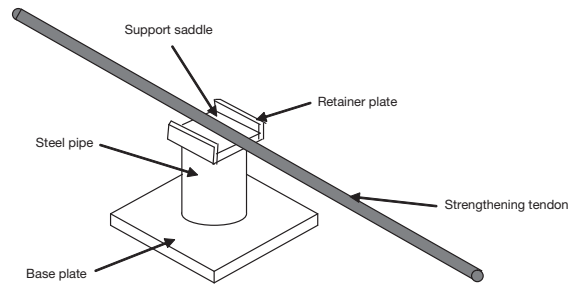

Fig. 30 – Sample of Slab Support Post

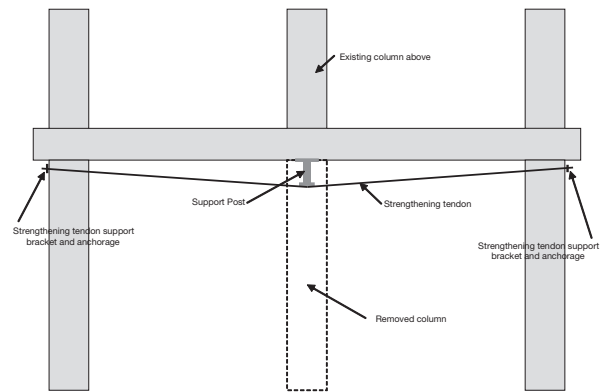

Fig. 31 – Example of Post-Tensioning Used When Removing a Column

#### 4.4 REMOVING COLUMNS

Removing columns in existing structures requires strengthening of the structure to carry the column load to the foundation. The column is typically removed to add open space to an area of the building. The column may be removed on one floor with columns remaining above/below or may be removed on each floor. Post-tensioning tendons can be used to transfer the column load to other supports that may exist or to new columns, beams, or walls.

The flexibility of post-tensioning tendons allows the Engineer to design a cost effective strengthening. An external straight-line tendon with a single support point is used. Fig. 31 displays a simplified example of post-tensioning used for column replacement. The support post would be similar to that shown in Fig. 30. The strengthening tendon would most likely be a multiple strand tendon depending on the required loading and allowable eccentricity.

When columns are removed on each floor, a strengthening scheme similar to Fig. 31 would be used on each floor to carry the slab loadings back to the foundations. The strengthening tendons could run in one direction or they may be placed orthogonally depending on the structure's analysis.



## 5.0 CONCLUSION

Only experienced Contractors and Engineers should carry out design and construction of repairs to post-tensioning tendons, modifications to existing post-tensioned structures, and strengthening structures through the use of post-tensioning. Thorough, careful investigations by the Engineer to determine proper solutions and processes for specific situations should be undertaken. Specialty contractors should employ knowledgeable and experienced personnel to perform the work.

Repair techniques and strategies for unbonded single strand tendons and unbonded button-headed wire tendons are straight forward. Repair complexity is based upon time of discovery, type of tendons involved, and the structure type. Identifying the necessity to repair a tendon prior to concrete placement is easier than afterward. Restoring integrity to tendons, both strand and button-headed wire, in existing structures can be complex but attainable.

Modifications to existing post-tensioned structures are not simple undertakings and require specialized knowledge, experienced personnel, and proper equipment. When cutting holes and openings into slabs containing unbonded post-tensioning tendons, the process involves accurately locating tendons, excavating concrete around tendons, detensioning and cutting tendons, and re-anchoring tendons at the edge of the new openings.

Strengthening structures with post-tensioning tendons permits the required strengthening forces to be applied where needed. External tendons are easily attached to structures or encased in concrete. Tendon geometry can be adjusted to work around existing site conditions.

## REFERENCES

- 1 Greenhaus, S., and Poston, R. W., *Evaluation and Repair of Corrosion-Damaged Unbonded Post-Tensioning Concrete Structures*.
- 2 Nehil, T. E., "Rehabilitating Parking Structures with Corrosion-Damaged Button-Headed Post-Tensioning Tendons," *Concrete International*, October 1991.
- 3 Schupack, M., "Corrosion Protection for Unbonded Tendons," *Concrete International*, February 1991.
- 4 Elliott, J. F., "Monitoring Prestressed Structures," *Civil Engineering*, July 1996.
- 5 Poston, R. W., and Dalrymple, G. A., "Repairing Unbonded Post-Tensioned Concrete," *Concrete Repair Digest*, April/May 1993.

- 6 *Field Procedures Manual for Unbonded Single Strand Tendons*, 3<sup>rd</sup> Edition, Post-Tensioning Institute, Phoenix, AZ, 2000.
- 7 *Post-Tensioning Manual*, 3<sup>rd</sup> Edition, Post-Tensioning Institute, Phoenix, AZ, 1981.
- 8 Fischli, F., Grimm, M., and Marti, P., "Cutting Openings into Post-Tensioned Floor Slabs," *Concrete International*, February 1988.
- 9 *Post-Tensioning Manual*, 5<sup>th</sup> Edition, Post-Tensioning Institute, Phoenix, AZ, 1990.

## RELATED READING

Bonin, D., "The Case of the Missing Grout," *Concrete Repair Bulletin*, July/August 1995.

Greenhaus, S., "Structural Retrofit Brings Underground Parking Structure up to Standards," *Concrete Repair Bulletin*, March/April 1997.

Kesner, K., and Poston, R. W., "Unbonded Post-Tensioned Concrete Corrosion: Myths, Misconceptions and Truths," *Concrete International*, July 1996.

Small, J., "Evaluating Unbonded Post-Tensioned Slabs," *Concrete Repair Bulletin*, July/August 1995.

Tracy, R., Lozen, K., and Zeort, K. R., "Restoration of a Deteriorated Post-Tensioned One-Way Slab," *Concrete International*, March 1992.

*Building Code Requirements for Structural Concrete and Commentary*, ACI 318-02/318R-02, American Concrete Institute, Farmington Hills, MI, 2002.

*Specification for Grouting of Post-Tensioned Structures*, 2<sup>nd</sup> Edition, Post-Tensioning Institute, Phoenix, AZ, 2003.

**The photos contained herein are used courtesy of DYWIDAG-Systems International, USA**

**Larry B. Krauser**, is the principal of Krauser Consulting Group, LLC, Spokane, WA, specializing in training, quality management, and business consulting. He is Chairman of PTI's Certification Committee and a past member of the PTI Board of Directors. He has a degree in construction management from Purdue University and has spent close to 30 years in the construction industry.